

BV3B-Series Industrial Brass Ball Valve

Sizes

- 1/4", 3/8", 1/2", 3/4", 1", 1-1/4", 1-1/2", 2", 2-1/2", 3"

Features

- Reduced port brass ball
- ISO 5211 mounting pad
- Blow-out proof stem
- Double O-ring stem packing

Materials

- Product contact metal components: lead-free brass
- Chrome plated brass ball
- FKM elastomers
- PTFE seats with O-ring backing for low operation torque



Specifications

- Standard connection: FNPT
- Pressure rating: **400 PSI WOG; 100 PSI WSP**
- Operating temperature range: **-4°F to 366°F (-20°C to 185°C)**

Size	L-Port Part #	T-Port Part #	Flow Coefficient (Cv)	Weight (lbs)	Break Torque ¹ (in-lbs)	ISO 5211
1/4"	BV3BVLR-0251-A	BV3BVTR-0251-A	3.24	1.23	35.4	F03
3/8"	BV3BVLR-0381-A	BV3BVTR-0381-A	3.47	1.16	35.4	F03
1/2"	BV3BVLR-0501-A	BV3BVTR-0501-A	4.16	1.21	35.4	F03
3/4"	BV3BVLR-0751-A	BV3BVTR-0751-A	7.05	1.48	35.4	F03
1"	BV3BVLR-1001-A	BV3BVTR-1001-A	12.83	2.7	70.81	F05
1-1/4"	BV3BVLR-1251-A	BV3BVTR-1251-A	18.73	4.15	88.51	F05
1-1/2"	BV3BVLR-1501-A	BV3BVTR-1501-A	29.71	6.22	106.21	F05
2"	BV3BVLR-2001-A	BV3BVTR-2001-A	43.81	11.07	177.02	F07
2-1/2"	BV3BVLR-2501-A	BV3BVTR-2501-A	70.05	19.78	265.52	F07
3"	BV3BVLR-3001-A	BV3BVTR-3001-A	70.05	19.63	265.52	F07

¹Torque values are measured with water at 68°F (20°C) at 0 PSI.

BV3B-Series Industrial Brass Ball Valve - Pressure Temperature Chart

0.25 in - 3.00 in

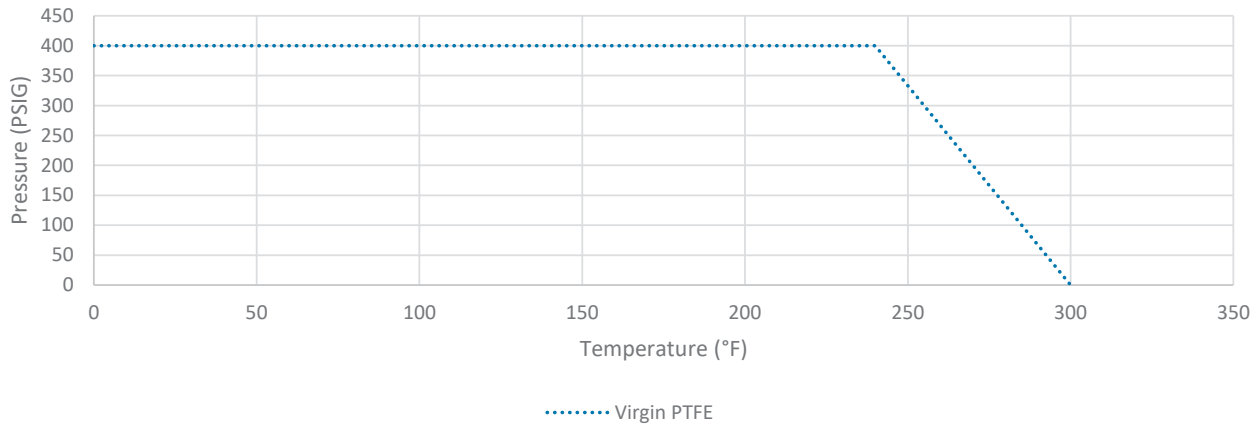

BV3-Series Industrial Actuated Ball Valve - Part Number Key

BV3-Series Industrial Actuated Ball Valve Part Number Key Example: 3BLV031100XX10		Valve Style	Seat Material	Size	Connections				
		3BL	V	03	1				
BV3B/BV3I Valve Style	Code	←	←	←	←				
Brass 3-way L-port	3BL								
Brass 3-way T-port	3BT								
Stainless steel 3-way L-port	3IL								
Stainless steel 3-way T-port	3IT								
Seat Material	Code	←	←	←	←				
Virgin-PTFE (3B valve style only)	V								
RTFE (15% glass reinforced PTFE) (3I valve styles only)	G								
Size	Code	←	←	←	←				
1/4"	03								
3/8"	38								
1/2"	50								
3/4"	75								
1"	10								
1-1/4"	13								
1-1/2"	15								
2"	20								
2-1/2" (3B valve style only)	25								
3" (3B valve style only)	30								
Connections	Code					←	←	←	←
Female NPT	1								

Continue number selection by following column 1 (pneumatic actuators) or 2 (electric actuators) below.

1. Pneumatic Actuator or Spring Return Manual Handle				2. Electric Actuator				
Actuator	Feedback	Control	Flow Path	Actuator	Voltage	Option 1	Option	Flow Path
1	XX	00	10	E	B	1	1	12
Actuator			Code	Actuator			Explosion Proof	Code
Aluminum spring return pneumatic rack and pinion			1	Electric				E
Aluminum double acting pneumatic rack and pinion			2	Oversized (1-UP) electric				F
Stainless steel spring return pneumatic rack and pinion			3	Explosion proof (Class I Div I group C and D, Class II Div I group E, F, and G) electric				G
Stainless steel double acting pneumatic rack and pinion			4	Electric with riser kit				H
Dead man spring return handle			6	Voltage			Explosion Proof	Code
Oversized (1-UP) aluminum spring return pneumatic rack and pinion			7	115VAC			15VAC	B
Technopolymer spring return pneumatic rack and pinion			8	12VDC			n/a	C
Oversized (1-UP) aluminum double acting pneumatic rack and pinion			9	n/a			24VAC	D
Manual handle with riser kit			A	24VDC/AC			24VDC	E

BV3-Series Industrial Actuated Ball Valve - Part Number Key

1. Pneumatic Actuator or Spring Return Manual Handle				2. Electric Actuator				
Actuator	Feedback	Control	Flow Path	Actuator	Voltage	Option 1	Option	Flow Path
1	XX	00	10	E	B	1	1	12
Feedback			Code	Voltage			Explosion Proof	Code
None			00	220VAC			220VAC	F
Limit switch box, position indicator, (2) SPDT mechanical switches			11	12VAC			n/a	G
Limit switch box, position indicator, (2) switches, magnetic reed SPDT, hermetically sealed, up to SIL3, Exia ready, cULus Class 1/2 Div 2, NEMA 4 and 4X			12	Option 1				Code
Limit switch box, position indicator, AS-I			13	None				1
Limit switch box, position indicator, (2) proximity SPDT switches, aluminum Exd IIB certified enclosure			14	Torque switches				2
Limit switch box, position indicator, (2) DPDT mechanical switches			15	4-20mA input/output modulating controller				3
Limit switch box, position indicator, (2) switches, electro mec. SPDT, silver contacts, up to SIL3, cULus Class 1/2 Div 1			16	Current position transmitter				4
Limit switch box, position indicator, inductive proximity P+F NBB2-V3-E2, 3 wire PNP NO			17	Potentiometer				5
Limit switch box, position indicator, 4-20ma analog position transmitter			18	Local control unit				6
Limit switch box, position indicator, SPDT proximity, 0.25A @120VAC, 0.416A @ 48VDC, resistive			19	Two extra travel cams and switches				7
Limit switch box, position indicator, 4-20ma analog position transmitter + 2 SPDT mechanical switches			20	Three position cam set				8
Stainless steel limit switch box, position indicator, (2) proximity SPDT switches			21	Local control unit with lock				9
Control			Code	1-5V input/2-10V output modulating controller				A
None			XX	2-10V input/output modulating controller				B
Single coil solenoid, 120VAC			AA	75% duty cycle				C
Single coil solenoid, 24VDC			AB	Relay				D
Single coil solenoid, 12VDC			AC	Four position cam set				E
Single coil solenoid, 220VAC			AD	25% duty cycle (actuator code G only)				F
Dual coil solenoid, 120VAC			AE	75% duty cycle (actuator code G only)				G
Dual coil solenoid, 24VDC			AF	Option 2				Code
Dual coil solenoid, 220VAC			AG	None				1
Pneumatic positioner 3-15psi input, no feedback			AH	Torque switches				2
Pneumatic positioner 3-15psi input, (2) SPDT mechanical switches for feedback			AI	4-20mA input/output modulating controller				3
Pneumatic positioner 3-15psi input, 4-20mA for feedback			AJ	Current position transmitter				4
Electropneumatic positioner 4-20mA input, no feedback			AK	Potentiometer				5
Electropneumatic positioner 4-20mA input, (2) SPDT mechanical switches for feedback			AL	Local control unit				6
Electropneumatic positioner 4-20mA input, 4-20mA for feedback			AM	Two extra travel cams and switches				7
Electropneumatic positioner 0-10v input, no feedback			AN	Three position cam set				8
Electropneumatic positioner 0-10V input, (2) SPDT mechanical switches for feedback			AO	Local control unit with lock				9
				1-5V input/2-10V output modulating controller				A

BV3-Series Industrial Actuated Ball Valve - Part Number Key

1. Pneumatic Actuator or Spring Return Manual Handle				2. Electric Actuator				
Actuator	Feedback	Control	Flow Path	Actuator	Voltage	Option 1	Option	Flow Path
1	XX	00	10	E	B	1	1	12
Electropneumatic positioner 0-10v input, 4-20mA for feedback			AP	2-10V input/output modulating controller				B
V200 rotary electropneumatic positioner 4-20mA input, 4-20mA feedback			AQ	75% duty cycle				C
Electropneumatic positioner 4-20mA input, no feedback, Class 1, Div II explosion proof			AR	Relay				D
Single coil solenoid, 24VDC and 24V banjo solenoid valve with form B plug			AS	Four position cam set				E
Single coil solenoid, 24VDC, AS-I, 2.5W low power			AT	25% duty cycle (actuator code G only)				F
Single coil solenoid, 24VDC, intrinsically safe			AU	75% duty cycle (actuator code G only)				G
Single coil solenoid, 24VDC, pre-wired to limit switch with cordset (dual keyway, 1/2"-20 UNF mating thread, single ended, straight female connector, 22 AWG PVC, auto color code 2P to 6P cable, 12' length)			AV	Flow Path				Code
Single coil solenoid, 24VDC, explosion proof, Class H coil			AW	Energize A, Energize B				12
Single coil solenoid, 24VAC			AX	Energize A, Energize D				13
V200 rotary electropneumatic positioner 4-20mA input, 4-20mA feedback, Class 1, Div II explosion proof			AY	Energize A, Energize B, Energize D (80°)				39
Single coil solenoid, 24VDC, molded LED, ind. form, 2M leads			AZ					
TUFRAM coated electropneumatic positioner 4-20mA input, no feedback			BA					
V200 rotary pneumatic positioner, (2) REED SWITCH feedback			BB					
Single coil solenoid, 120VAC, explosion proof, Class H coil			BC					
Single coil solenoid, 24VDC, pre-wired to limit switch, 6P male connector			BD					
Flow Path			Code					
Rest A, Energize B (spring return)			10					
Rest A, Energize D (spring return)			11					
Energize A, Energize B (double acting)			12					
Energize A, Energize D (double acting)			13					
Rest B, Energize A, Energize D (spring return, 180°)			14					
Rest B, Energize A (spring return)			15					

NOTE: Refer to the flow path codes on the following pages for other available configurations.

BV3B-Series Industrial Brass Ball Valve - Flow Path Codes

3-Way L-Port

A



B



C



3-Way T-Port

A

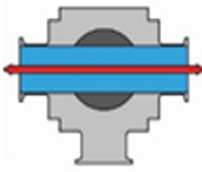

B

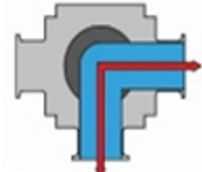

C



D

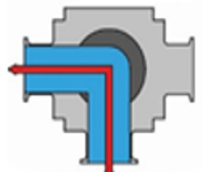

4-Way L-Port

A



B



C



D

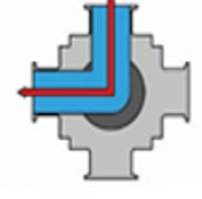

4-Way T-Port

A



B



C

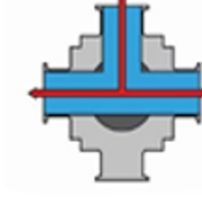

D

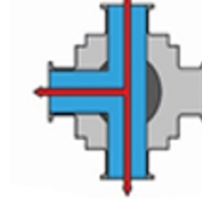

BV3B-Series Industrial Brass Ball Valve - Flow Path Codes

2 Position

3-Way | L-Port | Spring Return

Code	10	16	15	17	18	19
Rotation	90°	90°	90°	90°	90°	90°
Air Rotation Detection	CCW	CW	CW	CCW	CCW	CW
	A	A	B	B	C	C
Rest Position						
	B	C	A	C	A	B
Energize Position						

3-Way | L-Port | Double Acting or Electric

Code	12	20	21
Rotation	90°	90°	90°
	A	A	B
Energize Position			
	B	C	C
Energize Position			

BV3B-Series Industrial Brass Ball Valve - Flow Path Codes

3-Way | T-Port | Spring Return

Code	10	16	15	11	17	18
Rotation	90°	180°	90°	90°	90°	180°
Air Rotation Detection	CW	Either	CCW	CCW	CW	Either

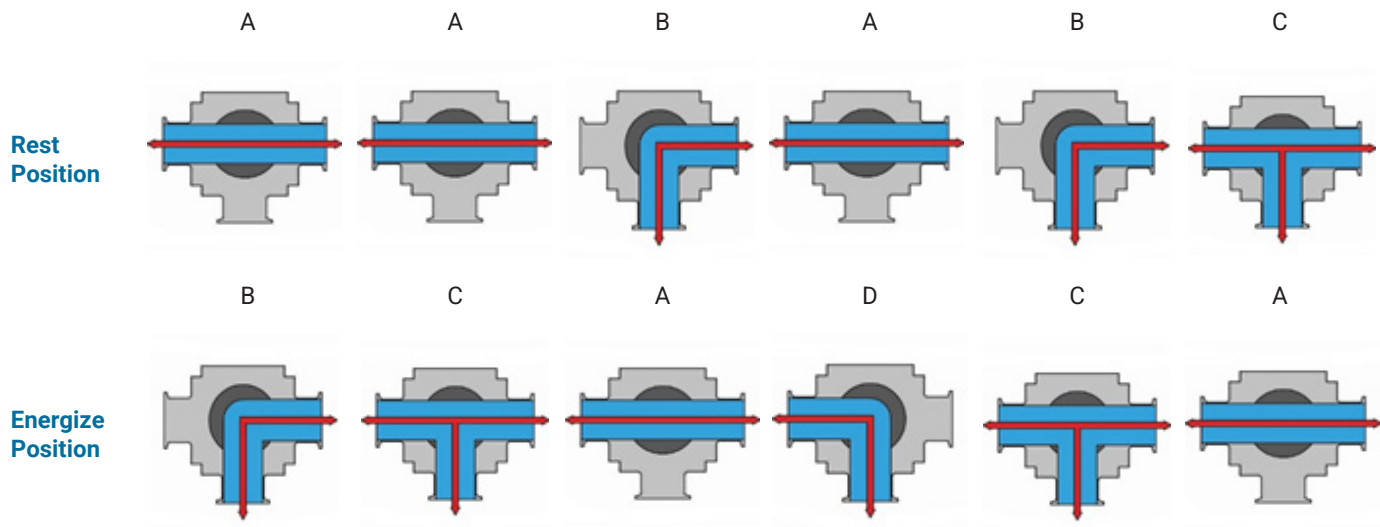

Code	19	22	23	24
Rotation	90°	90°	90°	90°
Air Rotation Detection	CCW	CW	CW	CCW

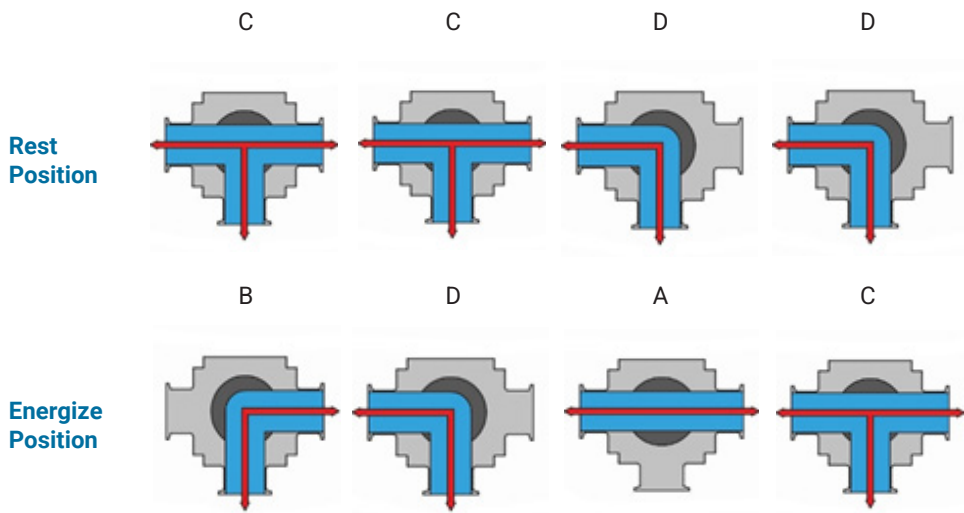

BV3B-Series Industrial Brass Ball Valve - Flow Path Codes

3-Way | T-Port | Double Acting or Electric

Code	12	20	13	21	25
Rotation	90°	180°	90°	90°	90°

A A A B D

Energize Position

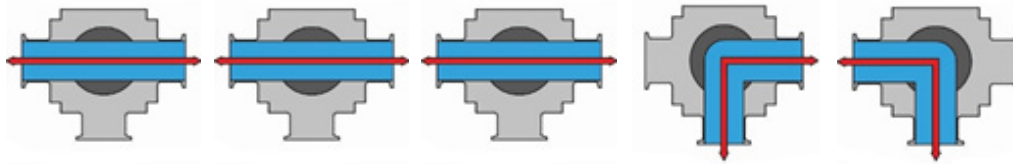

B C D C C

Energize Position

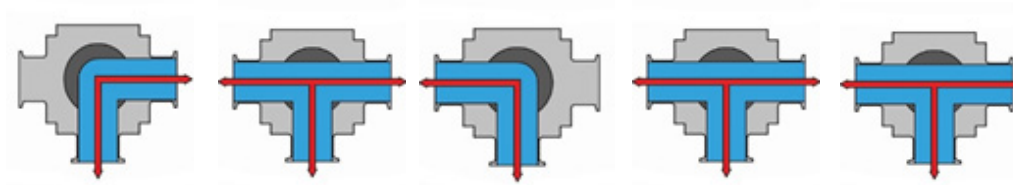

4-Way | L-Port | Spring Return

Code	10	16
Rotation	180°	180°
Air Rotation Detection	Either	Either

A A

Rest Position

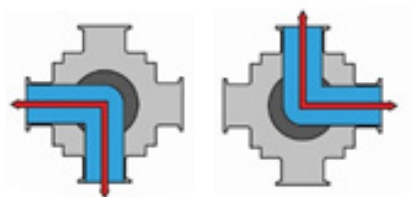

B C

Energize Position

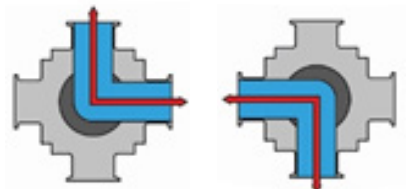

4-Way | L-Port | Double Acting or Electric

Code	12
Rotation	180°

A

Energize Position



B

Energize Position



BV3B-Series Industrial Brass Ball Valve - Flow Path Codes

4-Way | T-Port | Spring Return

Code	10	16	11	15	18	23
Rotation	90°	180°	90°	90°	90°	180°
Air Rotation Detection	CCW	Either	CW	CW	Either	CCW

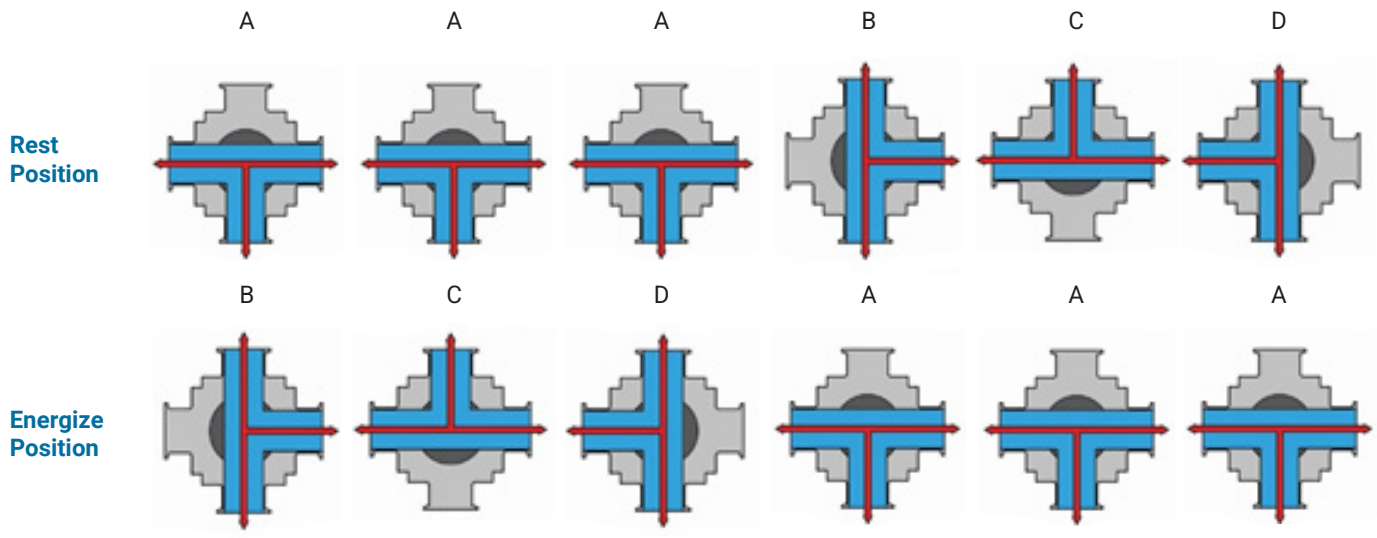

4-Way | T-Port | Double Acting or Electric

Code	12	20	13
Rotation	90°	180°	90°

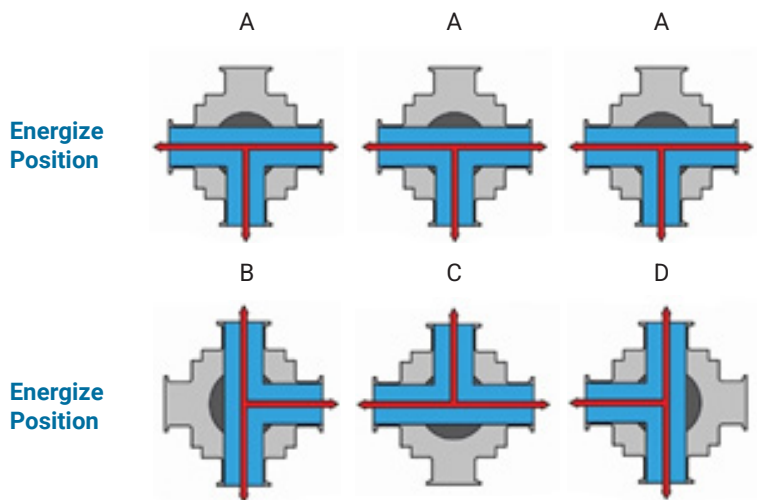

BV3B-Series Industrial Brass Ball Valve - Flow Path Codes

3 Position

3-Way | L-Port | Spring Return

Code	26	28	29
Rotation	180°	180°	180°
Air Rotation Detection	Either	Either	Either
Return	Either	Either	End

A

B

C

Rest Position



B

A

A

Energize Position



C

C

B

Energize Position

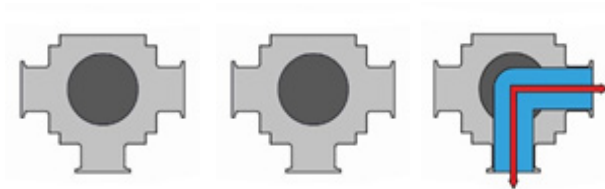

3-Way | L-Port | Double Acting or Electric

Code	30
Rotation	180°

A

Energize Position

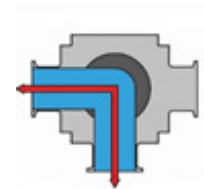

B

Energize Position



C

Energize Position

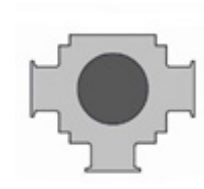

BV3B-Series Industrial Brass Ball Valve - Flow Path Codes

3-Way | T-Port | Spring Return

Code	26	27	31	28	14	32
Rotation	180°	180°	180°	180°	180°	180°
Air Rotation Detection	CW	Both	CCW	Both	CCW	CW
Return	End	Center	End	Center	End	End

A A A B B B

Rest Position

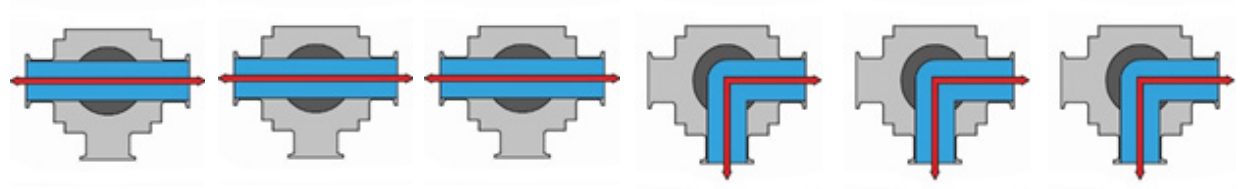

B B D A A C

Energize Position

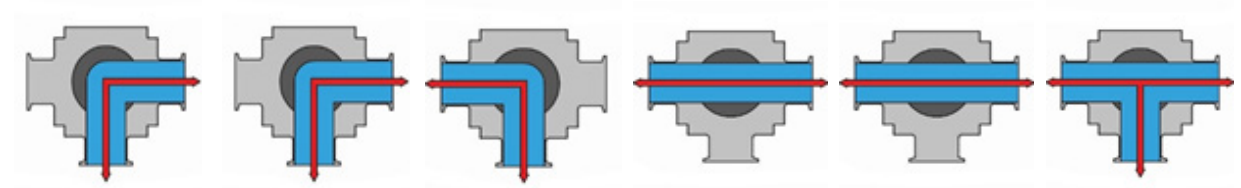

C D C C D D

Energize Position

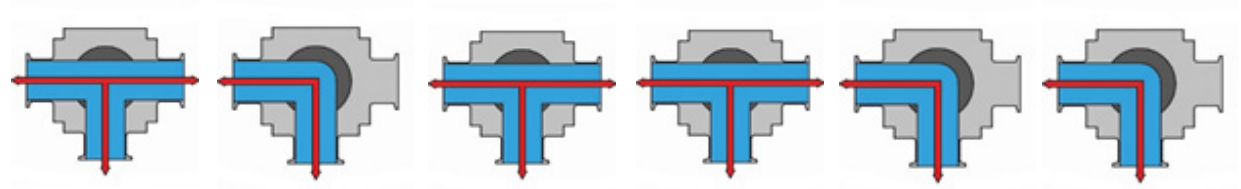

BV3B-Series Industrial Brass Ball Valve - Flow Path Codes

3-Way | T-Port | Spring Return

Code	33	34	35	36	37	38
Rotation	180°	180°	180°	180°	180°	180°
Air Rotation Detection	CCW	CW	Both	CW	Both	CCW
Return	End	End	Center	End	Center	End

C

C

C

D

D

D

Rest Position



B

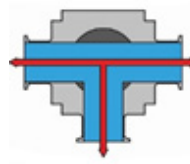

D

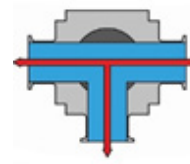

B

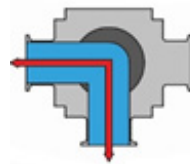

A

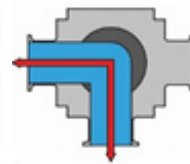

A

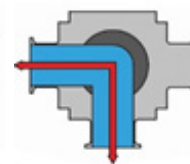

B

Energize Position



A

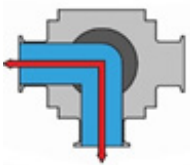

A

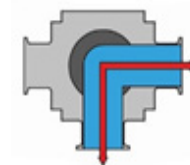

D

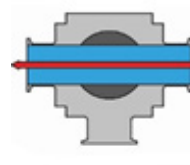

B

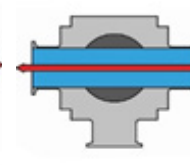

C

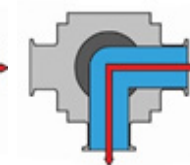

C

Energize Position

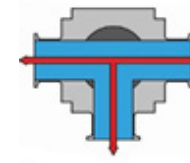
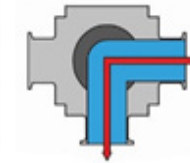
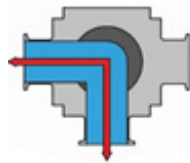
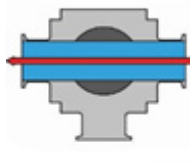
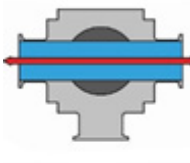

BV3B-Series Industrial Brass Ball Valve - Flow Path Codes

3-Way | T-Port | Double Acting or Electric

Code	30	39	40	41
Rotation	180°	180°	180°	180°

A

B

A

B

Energize Position

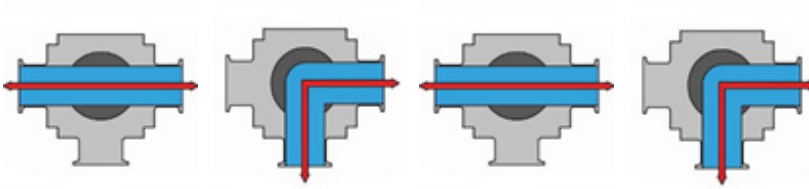

B

A

C

C

Energize Position

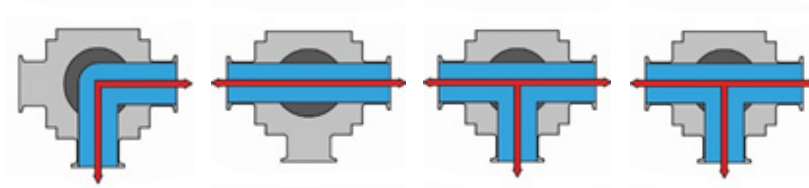

C

D

D

D

Energize Position

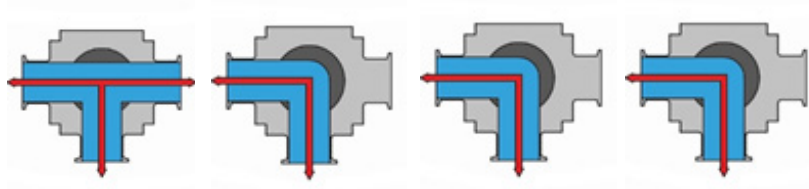

BV3B-Series Industrial Brass Ball Valve - Bill of Materials

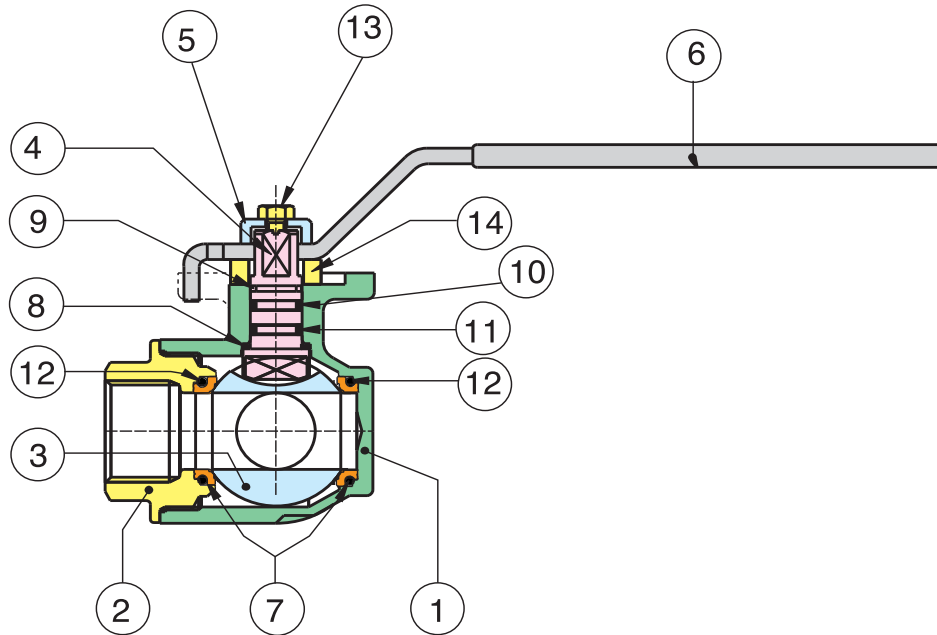

Item #	Description	Material	Qty
1	body	brass C37700	1
2	end connection	brass C37700	3
3	ball	brass C37700	1
4	stem	brass C37700	1
5	bushing	brass C37700	1
6	handle	Fe DD 11 UNI EN 10111	1
7	ball seat	PTFE	4
8	thrust washer	PTFE	1
9	thrust washer	PTFE	1
10	O-ring	EPDM	1
11	O-ring	FKM	1
12	body O-rings	FKM	4
13	screw	steel CL 8.8	1
14	washer	nylon (PA6)	1

BV3B-Series Industrial Brass Ball Valve - Dimensions

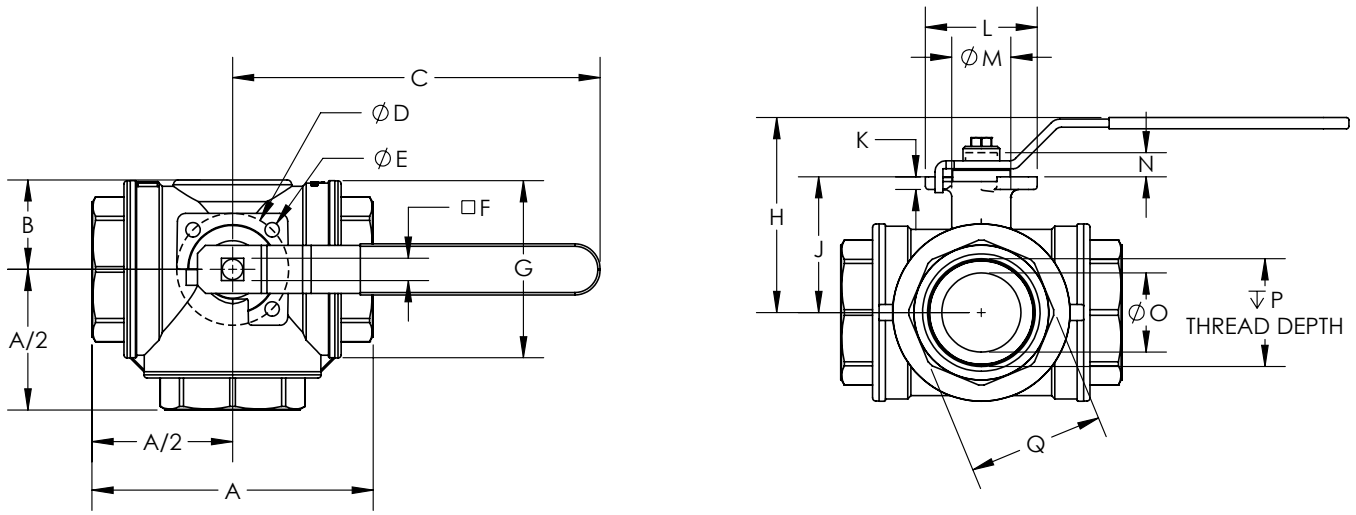

Size	A (in)	B (in)	C (in)	ΦD (ISO 5211)	ΦE (in)	F (mm)	G (in)	H (in)	J (in)	K (in)	L (in)	ΦM (in)	N (in)	ΦO (in)	J P (in)	Q (in)					
1/4"	2.64	0.77	4.72	1.42 (F03)	0.24	9	1.34	2.44	1.20	0.20	1.49	0.87	0.35	0.39	0.39	0.87					
3/8"														0.43	0.41						
1/2"	2.87	0.87					6.79	1.97 (F05)	0.28					11	1.54	2.52	1.29	0.94	0.43	0.54	1.06
3/4"	3.19														0.55	0.55	1.26				
1"	3.74	1.00	9.06	2.76 (F07)	0.35	14	1.89	2.95	1.63	1.26	1.46	0.59	0.75	0.66	1.61						
1-1/4"	4.39	1.22					6.79	1.97 (F05)	0.28				11	2.36	3.17	1.85	0.28	1.97	0.94	0.43	0.95
1-1/2"	4.86	1.49	9.06	2.76 (F07)	0.35	14	2.83	3.66	2.34	0.31	2.75	1.46	0.59	1.18	0.93	3.35					
2"	5.73	1.75					6.79	1.97 (F05)	0.28					11			3.39	4.37	2.91	1.50	0.70
2-1/2"	6.93	2.20	9.06	2.76 (F07)	0.35	14	4.37	4.80	3.35	0.31	2.75	1.46	0.59	1.95	1.02	4.13					
3"	7.09						4.45							4.80			3.35	0.31	2.75	1.46	0.59

Limited Warranty

DIXON VALVE & COUPLING COMPANY, LLC (herein called "Dixon") warrants the products described herein and manufactured by Dixon to be free from defects in material and workmanship for a period of one (1) year from date of shipment by Dixon under normal use and service. Its sole obligation under this warranty being limited to repairing or replacing, as hereinafter provided, at its option any product found to Dixon's satisfaction to be defective upon examination by it, provided that such product shall be returned for inspection to Dixon's factory within three (3) months after discovery of the defect. The repair or replacement of defective products will be made without charge for parts or labor. This warranty shall not apply to: (a) parts or products not manufactured by Dixon, the warranty of such items being limited to the actual warranty extended to Dixon by its supplier; (b) any product that has been subject to abuse, negligence, accident, or misapplication; (c) any product altered or repaired by others than Dixon; and (d) normal maintenance services and the replacement of service items (such as washers, gaskets, and lubricants) made in connection with such services. To the extent permitted by law, this limited warranty shall extend only to the buyer and any other person reasonably expected to use or consume the goods who is injured in person by any breach of the warranty. No action may be brought against Dixon for an alleged breach of warranty unless such action is instituted within one (1) year from the date the cause of action accrues. This limited warranty shall be construed and enforced to the fullest extent allowable by applicable law.

Other than the obligation of Dixon set forth herein, Dixon disclaims all warranties, express or implied, including but not limited to any implied warranties of merchantability or fitness for a particular purpose, and any other obligation or liability. The foregoing constitutes Dixon's sole obligation with respect to damages, whether direct, incidental, or consequential, resulting from the use or performance of the product.

Some products and sizes may be discontinued when stock is depleted or may require a minimum quantity for ordering.

Limits of Liability

This brochure is intended as a product offering. It is not intended to be a user or technical manual. Information in this brochure is subject to change without notice. All users and distributors of products sold through this brochure should contact Dixon with questions of use, compatibilities, coupling procedures, and life of product. Our full-time engineering and test staff are always available to recommend uses and to assist distributors and users with any questions.



Safety



Safety logos, which appear throughout our catalog, are used as a reminder that the user should carefully review for the appropriateness of the product for the media, application, and environment in which it will be used.

NOTE: Because of the health hazards associated with contamination and lead content in drinking water systems, Dixon couplings, unless otherwise specifically approved, are not recommended for potable water service and should not be used in applications where drinking water will contact the wetted surfaces of the coupling.

All Dixon products are shipped in cartons with the following warning:

"WARNING: This product contains lead, a chemical known to the State of California to cause cancer and birth defects or other reproductive harm."

Trademark

Delrin® and Zytel® are registered trademarks of E. I. du Pont de Nemours and Company.

Kalrez® is a registered trademark of DuPont Dow Elastomers.

All other trademarks appearing in the Dixon illustrated product list are the property of their respective owners.

Copyright

Copyright © 2026 by Dixon Valve & Coupling Company, LLC

All rights reserved. This book is copyrighted material. Use, reproduction or copying of it by anyone other than Dixon® is strictly forbidden without its express written consent.

NOTE: Reasonable care has been taken in preparing this catalog. Dixon Valve & Coupling Company, LLC reserves the right to make corrections.

