

Petrochemical Life Cycle **2 Refining**

The content in this phase of the Petrochemical Life Cycle is focused on the numerous transfer and control applications in the oil and gas field. Featured are the Dixon® products used within the Refining market place.

Please refer to the Dixon® Price List or dixonvalve.com for specific part numbers and various other products used in the transfer and control of liquids, gases and dry materials.

Table of Contents

Dixon® Zero	3-10
Bellows Seal Valves; Globe and Gate; Forged and Cast	4-5
Valve Description Key	6
MannTek Style Dry Disconnect	7
Bayloc™ Dry Disconnects	7
Bayonet Style Dry Disconnects	8
Vent-Lock™ Safety Cam and Groove Couplers	9
Cryogenic Couplings	10
Terminal	11-14
Railroad Car Unloading/Loading Assemblies	11-12
Low Pressure Swivels	13
Safety Break-Away Couplings	14
Utility/General Purpose	15-21
Quick Connect Couplings	15
Boss™ Ground Joint / Washer Seal Steam Fittings	16
Cam and Groove Couplings	17-18
Ball/Butterfly/Gate Valves	19-20
Air and Water Utility Products	21

Safety

Dixon® couplings and retention devices are designed to work safely for their intended use. The selection of the proper hose, coupling and retention device, and the proper application of the coupling to the hose are of utmost importance.

Users must consider the size, temperature, application, media, pressure and hose and coupling manufacturer's recommendations when selecting the proper hose assembly components. Dixon® recommends that all hose assemblies be tested in accordance with the Association for Rubber Products Manufacturer's (ARPM) recommendations and be inspected regularly (before each use) to ensure that they are not damaged or have become loose. Visit ARPMINC.com for more information.

Where safety devices are integral to the coupling, they must be working and utilized. The use of supplementary safety devices such as safety clips or safety cables are recommended.

If any problem is detected, couplings must be removed from service immediately.

Dixon® is available to consult, train and recommend the proper selection and application of all fittings we sell. We strongly recommend that distributors and end users make use of Dixon® Testing and Recommendation Services. Call 877.963.4966 or visit dixonvalve.com to learn more.

Dixon® ZERO Products

Through innovation, design and application expertise our objectives are to improve productivity, reduce environmental and fugitive emissions, and improve the safety of the work environment near valves and couplings. We do this by assisting with **Zero Leak**, **Zero Loss**, **Zero Contamination** and **Zero Hassle**.

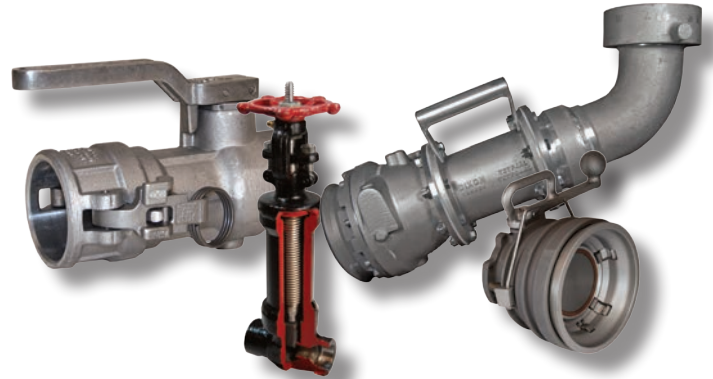

Refining Process

Crude fluids are processed and transferred via pipelines and hose assemblies throughout a refinery. Dixon® products are successfully utilized in many of these transfer and control applications, from basic utility hoses to zero emission bellows seal technology, from fire protection to no spill dry disconnects.

Dixon® is The Right Connection!

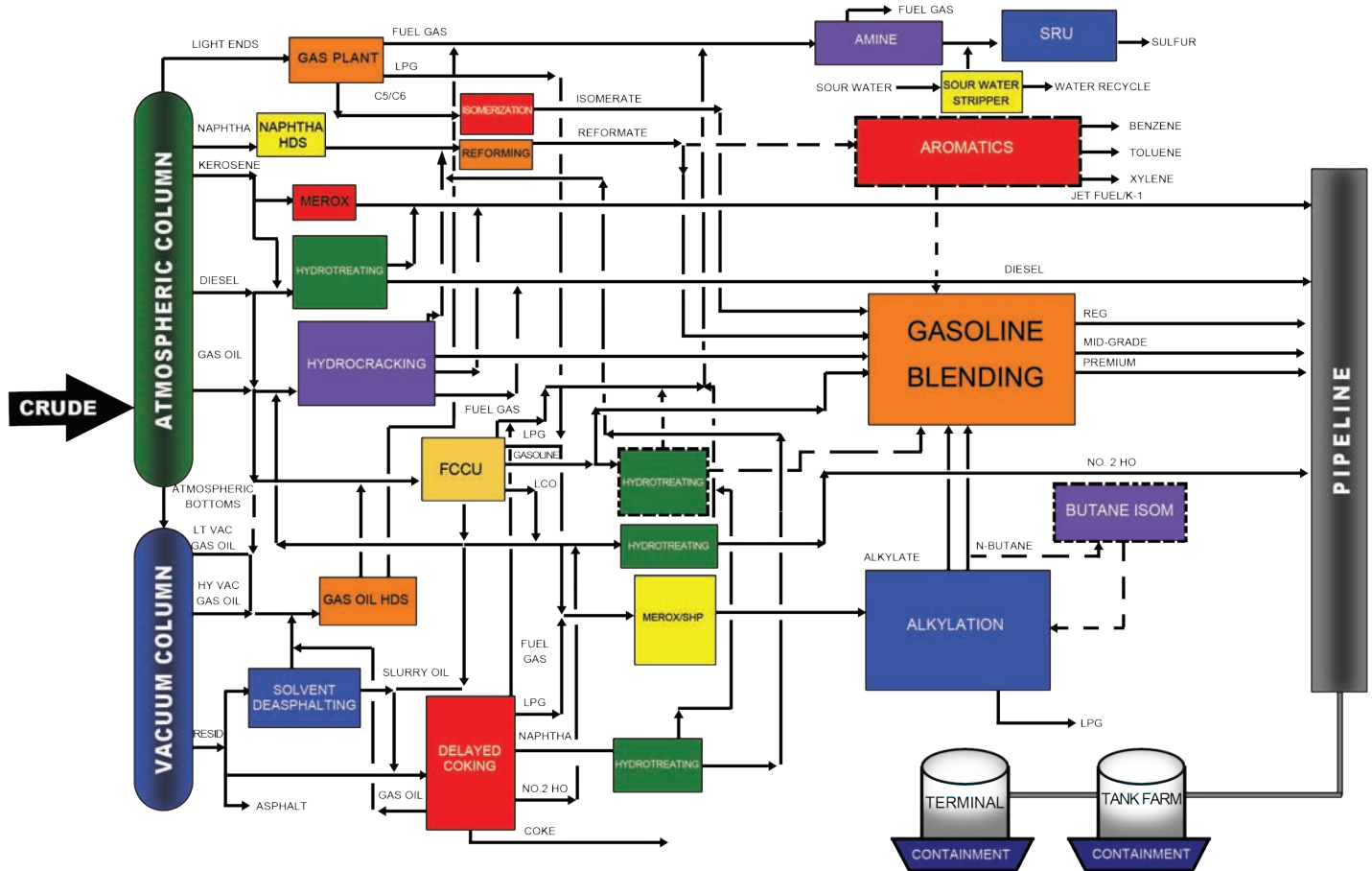

Fluid Catalytic Cracking Unit (FCCU)

Dixon Eagle Valves

Benefits of Bellows

Applications:

- These bellows are specifically designed to maintain a pressure seal within the relative motion caused by opening and closing the valve. This seal is also a safety device that prevents deadly or flammable gases from escaping into the atmosphere and provides an economical way to deter product loss.
- The seal also acts as a barrier to keep contaminants from entering the flow media.

Materials:

- We offer Inconel™ 625 bellows in all our valves due to its strength and added pressure and temperature resistance.
- Our welded bonnet design comes standard with a 321 stainless steel bellows, Inconel™ is optional.
- Hastelloy™ C-276 is available and commonly used for chlorine applications.
- Other exotic alloys, such as Monel™ are available.

How It Works

Hydraulically Formed Bellows

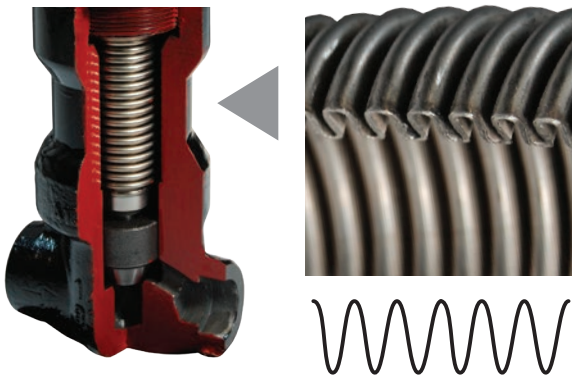

Formed bellows are more economical but require more vertical space

Welded Bellows

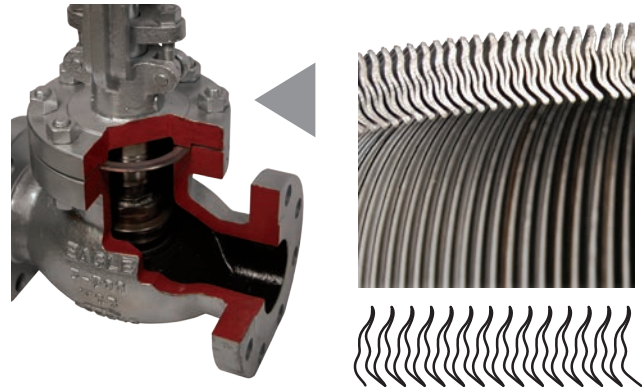

Welded piles "nest" together to create a shorter height; convenient for small spaces

Testing

- Dixon Eagle bellows are manufactured to have a high compressive strength, are heat and corrosion resistant, leak tight and highly flexible. They have also been emission tested per API 622 and earned the title of Low E valves. The bellows is designed to meet ASME B16.34 valve test requirements withstanding 1.5 times the working pressure of the valve. They are 100% pressure tested and 100% Helium leak tested under vacuum. The bellows leak rate must be less than 1×10^{-6} scc/sec in order to pass our stringent test requirements.
- Our metal bellows are designed and tested to meet or exceed the requirements of MSS SP-117 Bellows Seals for Globe and Gate Valves, and API 602 Annex C Type Testing of Bellows Stem Seals.
- The bellows cycle life tests are done while the bellows are under pressure and subjected to both ambient and elevated temperatures. The minimum cycle life requirements for sizes ½" - 4" up to 800 class are 2,000 for gate valves and 5,000 for globe valves.
- Dixon Eagle offers a **5 Year Bellows Fatigue Warranty** on all of our standard products.

Note: For additional information please contact Dixon Eagle at 800-314-9246.

Dixon Eagle Valves

Forged Gate and Globe Valves with Bellows Seal ½" - 2" Welded and Bolted Bonnets

Applications:

- These bellows are specifically designed to maintain a pressure seal within the relative motion caused by opening and closing the valve. This seal is also a safety device that prevents deadly or flammable gases from escaping into the atmosphere and provides an economical way to deter product loss.
- The seal also acts as a barrier to keep contaminants from entering the flow media.

Features:

- Inconel™ bellows (stainless steel bellows available for F8, H8 and GY series) provide long life and maximum corrosion resistance
- lower stem leakage eliminates media loss and satisfies environmental regulations
- lower maintenance results in decreased operating costs / no downtime
- reduces monitoring costs
- three stem seals for safety: metal bellows, graphite packing, backseat in open position
- hardfaced Stellite® 6 seating surface provides long life: soft seat available for globe valves
- additional alloys, trims and other end configurations available
- Class 150 - Class 600 available

Material:

- forged steel

Sizes:

- ½" - 2"

Standards:

- valves tested to ASME B16.34 / API 598
- meets MSS SP-117
- 5 year bellows warranty



H series
Gate Valve Class 800



F series
Globe Valve Class 800



GY series
Globe Valve

Cast Gate and Globe Valves with Bellows Seals 2½" - 24"

Application:

- These bellows are specifically designed to maintain a pressure seal within the relative motion caused by opening and closing the valve. This seal is also a safety device that prevents deadly or flammable gases from escaping into the atmosphere and provides an economical way to deter product loss.
- The seal also acts as a barrier to keep contaminants from entering the flow media.

Features:

- Inconel™ bellows provide long life and maximum corrosion resistance
- globe valves are very compact, lower piping costs
- lower stem leakage eliminates media loss and satisfies environmental regulations
- lower maintenance results in decreased operating costs / no downtime
- reduces monitoring costs
- three stem seals for safety: metal bellows, graphite packing, backseat in open position
- hardfaced Stellite® 6 seating surface provides long life: soft seat available for globe valves
- additional alloys, trims and other end configurations available
- Class 150 - Class 600 available

Material:

- cast steel

Sizes:

- globe valves 2½" - 16"
- gate valves 2½" - 24"

Standards:

- valve tested to ASME B16.34 / API 598
- meets MSS SP-117
- 5 year bellows warranty

Note: For additional information please contact Dixon Eagle at 800-314-9246.



J series
Globe Valve Class 150-300



L series
Gate Valve Class 150-300

Dixon™ Dry Disconnect Couplings

Application:

- applications where it is important to minimize product loss when connecting / disconnecting hose assemblies

Features:

- no need to drain hoses or pipe systems
- decreased spillage of liquids at connection or disconnection
- valve cannot be opened until the unit is coupled
- safe and reliable due to rugged construction
- produced according to NATO, standards STANAG 3756 and ATOFINA SGM 2049.TUY.C
- compatible with Mann-Tek, and Todo-matic® and other products produced according to NATO, standards STANAG 3756
- working pressure:
 - aluminum: **300 PSI** up to 4"
 - brass/ gunmetal : **300 PSI** up to 4"
 - stainless steel: **360 PSI**

Materials:

- aluminum, brass / gunmetal or stainless steel

Seal Materials:

- EPDM, NBR - Buna / Nitrile, Kalrez®, Chemraz®, FFKM

Sizes:

- ¾", 1", 1½", 2", 3", 4" and 6"



3" coupler pictured



Bayloc™ Dry Disconnects

Application:

- helps prevent spillage from normal or accidental disconnects

Features:

- compatible with most cam and groove style dry disconnects
- spring loaded sealing device "snaps" closed should the valve become disconnected with the poppet open
- two-piece adapter design allows easy rebuilding of adapters
- EZ Boss-Lock™ cam arms provide security against accidental opening
- automatic closing poppet assembly
- stainless steel handle allows product exposure to corrosive chemicals or wash down service
- fully interchangeable with Kamvalok® style fittings

Materials:

- stainless steel or aluminum
- call Dixon® for information on chemical compatibility, size, material selection and special configurations

Seal Materials:

- NBR - Buna / Nitrile, FKM, PTFE, EPDM

Sizes:

- 1½", 2" and 3" female NPT x 2", 2½" and 4" coupler and adapter



straight configuration coupler



DBA adapter

Dry Disconnect Couplings; Bayonet Style



coupler x straight female NPT -
BC62-200

Applications:

- Dixon® BA and BS series bayonet dry disconnect fittings are designed for use in the fuel and lube oil service industry.

Features:

- these fittings are compatible with Emco Wheaton™ Dry Break
- the maximum pressure rating for fittings is **85 PSI** at 70°F (21°C), for pressure ratings at other temperatures contact Dixon®
- for information on repair kits visit us online at dixonvalve.com

Materials:

- anodized aluminum coupler
- aluminum adapter
- brass adapter
- stainless steel adapter

Seal Materials:

- NBR - Buna / Nitrile, FKM

Sizes:

- 2" and 3"



coupler x 90° swivel female NPT -
BS62-200



adapter x female NPT -
BA32-200

Vent-Lock™ Safety Cam and Groove

Application:

- transfer of fluids and solids, with a safer disconnection

Features:

- safety release cam and groove couplings permit the release of static pressure when disconnecting hose assemblies
- venting system protects operator from being sprayed with hazardous or non-hazardous fluids or solids
- rated to **250 PSI**, recommendation based on the use of mating Dixon® L-style fittings at ambient temperature (**70°F**) with standard Buna-N seal installed, for use at elevated temperature or other unusual operating conditions, consult Dixon®
- does not interchange with standard cam and groove products use only with Dixon® L-style fittings
- safety orange powder coated cam arms

Materials:

- 316 stainless steel
- other materials to be available, contact Dixon®

Sizes:

- 1", 1½", 2" and 3"



Vent-Lock™ Type C



Vent-Lock™ Type A

Size	Vent-Lock™ Type A Part #	Vent-Lock™ Type C Part #	Vent-Lock™ Type E Part #	Vent-Lock™ Type DC Part #	Vent-Lock™ Type DP Part #
1"	L100-A-SS	L100-C-SS	L100-E-SS	L100-DC-SS	L100-DP-SS
1½"	L150-A-SS	L150-C-SS	L150-E-SS	L150-DC-SS	L150-DP-SS
2"	L200-A-SS	L200-C-SS	L200-E-SS	L200-DC-SS	L200-DP-SS
3"	L300-A-SS	—	L300-E-SS	—	L300-DP-SS

Cryogenic Couplings

Cryogenic Dry Disconnect Couplings



Applications:

- container discharge
- fuel bunkering
- loading / unloading of tank trucks, rail cars and ship tankers
- vapor recovery lines

Sizes:

- 1" - 6"

Features:

- connections: female NPT, flanged EN and ANSI, others available on request
- working pressure: 1" to 4" at 360 PSI, 6" at 230 PSI
- minimum working temperature: -320°F (-200°C)
- single action operation uses a straight forward turning motion to connect the couplings and open the flow path
- safe and reliable: valve cannot be opened until the unit is coupled and it closes automatically when disconnecting eliminating spills
- used with a wide range of cryogenic liquefied gases without the risk of cross connection due to human error

Material:

- stainless steel

Cryogenic Break-away Couplings



Applications:

- container discharge
- fuel bunkering
- loading / unloading of tank trucks, rail cars and ship tankers
- vapor recovery lines

Sizes:

- 1" - 6"

Features:

- connections: female NPT, flanged EN and ANSI, others available on request
- working pressure: 1" to 4" = 362 PSI, 6" = 232 PSI
- minimum working temperature: -328°F (-200°C)
- operates independently of shut-off safety system and does not require an external power source
- lightweight, easy to reset on-site with one person
- easy to repair on site with one person
- high flow rate / low pressure drop
- positive shut-off of both coupling halves results in minimum product loss
- available with ANSI / EN flanges or threaded (female NPT)
- passive security where a hose or loading arm could be subjected to inadvertent excessive loads
- can be installed at fixed points or in the middle of hose strings
- available as Industrial or Marine types
- no loose components which could be lost after release

Material:

- stainless steel

Note: Some applications require powered emergency release couplings (PERC). Please consult Dixon® for more information on these couplings

Rail Car Unloading

Rail Car Unloading/Loading Assemblies

Application:

- used with rail cars for bottom loading and unloading of crude oil and other media used in the petrochemical industry

Features:

- rugged body construction
- easy carry handle allows one person ability to install/disconnect
- safe and reliable - valves will not open unless fittings are properly connected
- API configuration uses a stainless steel spring on the adapter and coupler for corrosion resistance
- drain and sample ports and many other configurations are available, call Dixon® for information

Materials:

- body: aluminum
- components: aluminum, brass, steel

Size:

- 4"



Components for Custom Assemblies

- additional components are available, please email sales@dixonvalve.com or call 800.355.1991 for more information



4" transfer hose fittings



dry disconnect and API fittings



4" sight glass



4" flange extension



ball valve



mates to a tank car with
5" male tank car thread



mates to a tank car with
4" cam and groove connections

Rail Car Unloading: Dry Disconnect Couplers



Application:

- products used with rail car adapters

Features:

- coupler has built-in swivel
- shaft journal in stainless steel embedded in PTFE eliminates seizure
- riveted piston pin to minimize the risk for failure under extreme pressure conditions
- the protective ring is a specially formulated, weather resistant and electrically conductive rubber compound

Materials:

- aluminum
- rollers: aluminum-bronze on stainless steel shaft
- stainless steel ball bearings

Size:

- 4"

API Coupler



Feature:

- coupler includes a snap-on connection
- optional bonded nose seal assures proper alignment and minimizes a leak path

Materials:

- aluminum
- nose seal - bonded FKM-B

Size:

- 4"

Low Pressure Swivels

Applications:

- V-ring: loading arm, floating roof drain, floating suction
- O-ring: loading arm, hose loaders

Features:

- full 360° rotational movement offers maximum flexibility
- wide spacing between dual ball bearing raceways ensures greater load-bearing capacity
- precision-machined design ensures alignment and years of trouble-free service
- an O-ring dust seal protects the ball races and seal chamber from outside elements.
- radius elbow design ensures a smooth flow pattern

Materials:

- V-ring: carbon steel, stainless steel or aluminum
- O-ring: carbon steel, stainless steel, aluminum, brass or iron

Sizes:

- V-ring: 2" - 8"
- O-ring: 1" - 4"



Typical Applications

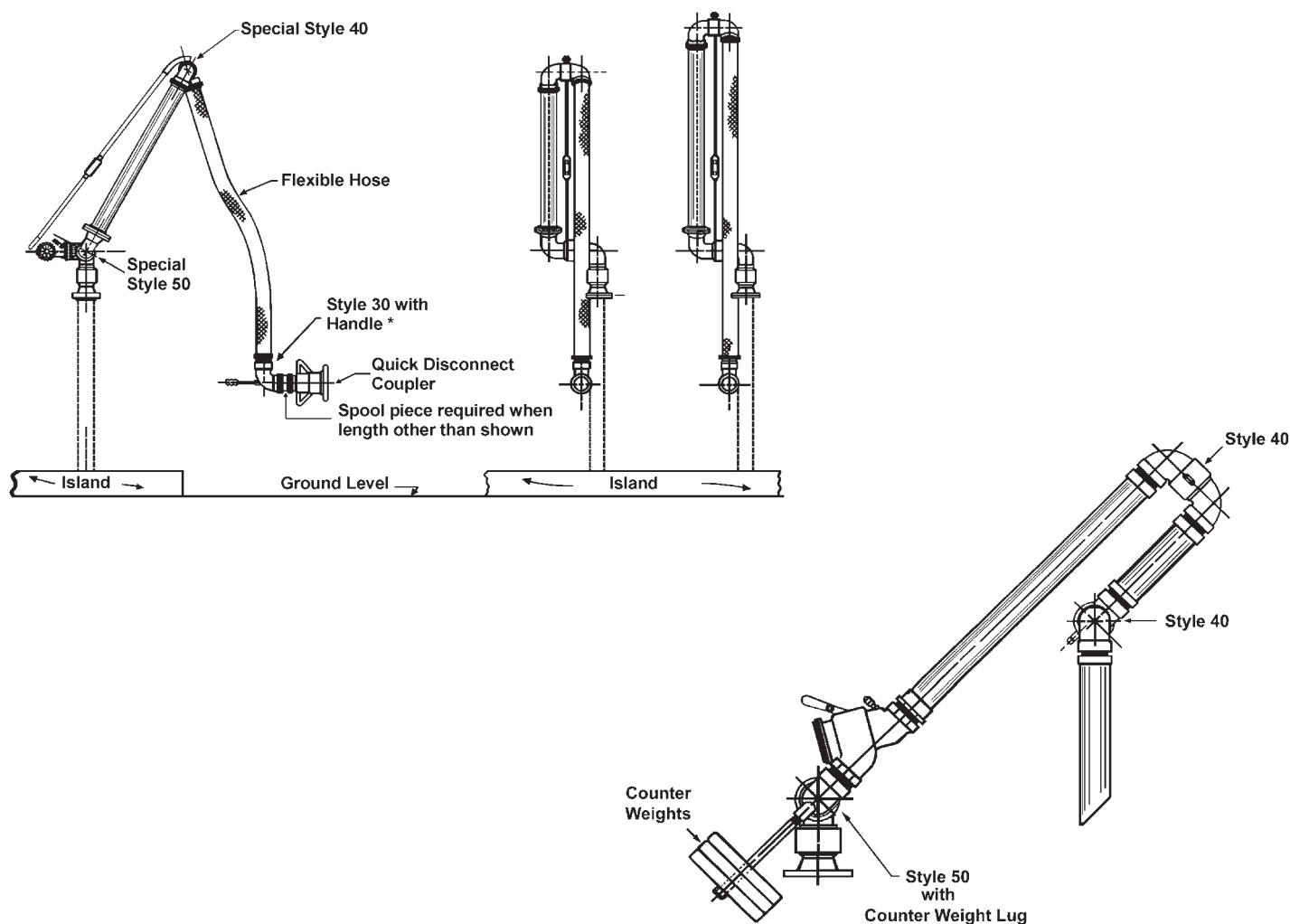

Safety Breakaway Couplings



marine version



industrial version

Application:

- used most commonly on tank trucks, railcars and barges to limit the possibility of environmental impact and loss of product resulting from a break in a connection

Features:

- marine version - hose to hose
- industrial version - fixed point to hose
- coupling automatically senses an excessive load, closes the valves and disconnects
- high flow rate / low pressure drop
- female NPT is standard, optional ANSI / DIN flanges or male NPT are available
- working pressure: stainless steel **360 PSI** and aluminum (industrial version) **230 PSI** at ambient temperature 70°F (21°C)

Materials:

- industrial version: 316 stainless steel or aluminum
- marine version: 316 stainless steel
- FKM(FPM) is standard seal

Sizes:

- 2", 3", 4", 5", 6" and 8"

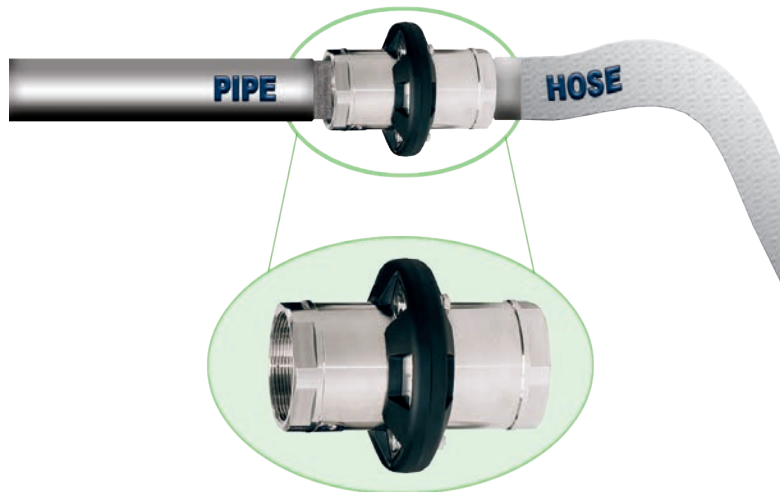

Industrial break-aways are typically installed on a loading arm or manifold and hose assemblies, where at least one side of the coupling is attached to a rigid or fixed point.

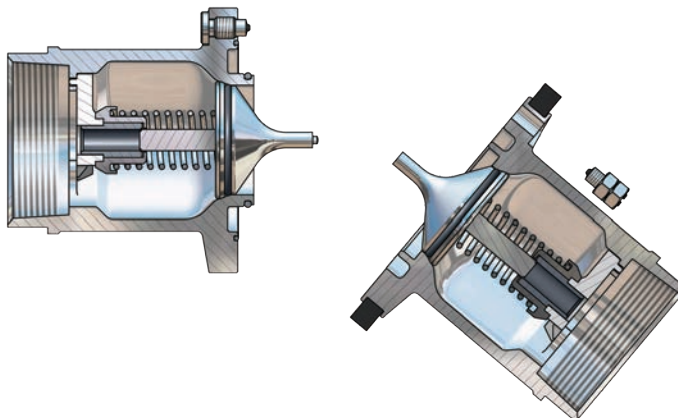

Release with a tensile force being applied at an angle to the plane of the coupling housing, up to 90 degrees.

N-Series Bowes Interchange

Application:

- full flow couplings used on utility air, water, and nitrogen lines, as well as pneumatic tools

Features:

- convenient push and twist connection and latch tab locking mechanism
- full flow design
- locking sleeve option
- protective nipple cap available
- hose barb end connections available with optional staked ferrule

Materials:

- steel
- brass
- 303 stainless steel
- pneumatically energized Nitrile seals standard. FKM available

Sizes:

- $\frac{3}{8}$ " and $\frac{1}{2}$ " body sizes
- $\frac{3}{8}$ " through 1" end connections

Interchange Data:

- Bowes 51000 Series
- MacDonald Quick-Action



P-Series Thor Interchange

Application:

- full flow couplings used on utility air, water, and nitrogen lines, as well as pneumatic tools

Features:

- convenient push and twist connection with latch finger locking mechanism
- full flow design
- sleeve locking clips available
- flanged sleeve option
- hose barb end connections available with optional staked ferrule

Materials:

- steel
- brass
- 303 stainless steel
- Nitrile seals are standard. FKM available

Sizes:

- $\frac{1}{2}$ " body size
- $\frac{3}{8}$ " through 1" end connections

Interchange Data:

- Thor PHC Series



V-Series General Purpose H/IH Interchange

Application:

- general purpose coupling for hydraulic and pneumatic service

Features:

- compliant with MIL-C-51234
- available in single shut-off, double shut-off, or straight through valve configurations for a variety of applications
- wide array of materials and end configurations

Materials:

- coupler and nipple: steel, brass or 316 stainless
- dust cap & plug: aluminum body with stainless steel bead chain, elastomer

Sizes:

- $\frac{1}{4}$ ", $\frac{3}{8}$ ", $\frac{1}{2}$ ", $\frac{3}{4}$ ", 1", 1 $\frac{1}{4}$ ", 1 $\frac{1}{2}$ " and 2"

Interchange Data:

- Snap-Tite H/IH, Faster TNV/TNL



Boss™ Ground Joints & Washer Seal

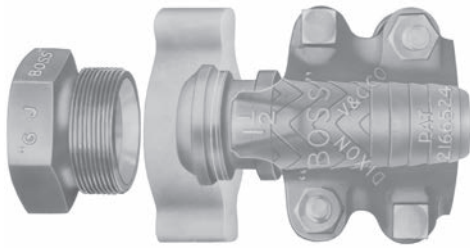

Boss™ Ground Joint



Boss™ Washer Seal

Application:

- hose couplings used in the transfer of steam, air, water and other petrochemical fluids

Features:

- A leakproof seal is formed when the metal head of the stem makes contact with the polymer seat in the spud.
- The non-metallic polymer seat resists most chemicals found in manufacturing facilities.
- easy to seal
- Klingersil® C-4401 washer is inserted between the stem and spud
- recommended for steam service up to **450°F (232°C)**

Materials:

- plated steel, brass, stainless steel

Sizes:

- ¼" - 6"

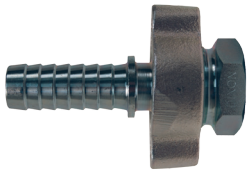

complete female



stem



wing nut



knurled nut



washer

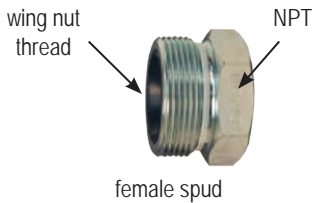

female spud

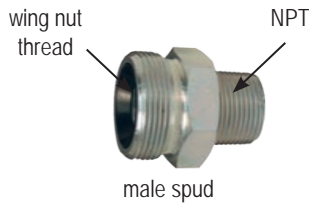

male spud

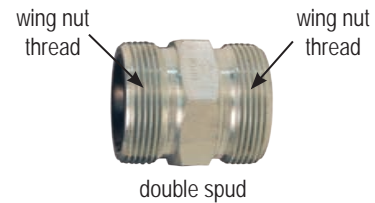

double spud

Cam and Groove Choices

Cam and Groove Specialty Configurations

Increasesers / Reducers

Features:

- Couplers are supplied standard with a Buna-N gasket.
- Pressure rating is based on the seal of the mating part.
- In reducing cam and groove couplings, the coupler is the first size in the part number; (i.e., a 4030-DA-AL is a 4" coupler to a 3" adapter).

Materials:

- aluminum, stainless steel, hastelloy, polypropylene, brass, ductile iron



cam and groove x flange



45° and 90° elbows



increaser / reducer
coupler x adapter



reducing adapter
male adapter x female NPT



spool coupler
coupler x coupler



spool adapter
adapter x adapter



coupler x wye adapters

EZ Boss-Lock™ and King Crimp™ Couplers

Applications:

- Suitable for water, chemical, acid, and crude transfer as well as other petrochemical applications; creates a reliable assembly when used with King Crimp™ sleeves and ferrules.

Features:

- positive lock handles - prevent accidental uncoupling (EZ Boss-Lock™ female couplers)
- handles lock automatically when closed (EZ Boss-Lock™)
- handles available in forged brass or investment cast stainless steel to meet chemical requirements
- sleeve and ferrule wall thickness varies from .062" to .120"
- working pressures are available, call Dixon® or visit dixonvalve.com for information

Materials:

- EZ Boss-Lock™: 316 stainless steel
- King Crimp™ couplers and adapters: aluminum, brass, 316 stainless steel or unplated iron
- sleeves and ferrules: stainless or carbon steel

Sizes:

- EZ Boss-Lock™ and King Crimp™ couplers and adapters: 1" - 6"
- King Crimp™ sleeves: 1" - 12"
- King Crimp™ ferrules: 1" - 8"



Not recommended for compressed gas, air or steam

Under no circumstances should the EZ Boss-Lock™ cam arms be used on any fitting not specifically designed for their use.



Pressure rating on King Crimp™ adapters is based on the seal of the mating part.

Only use the crimp style shanks with the crimp style sleeves and ferrules. Due to differences in dimensions and tolerances for safety reasons, do not interchange other manufacturer's products with Dixon® products.

Cam and Groove: Basic 8 Configurations

Line drawings are representative of the Dixon® line of cam and groove.

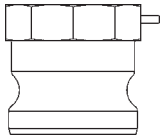

Type A
male adapter x female NPT

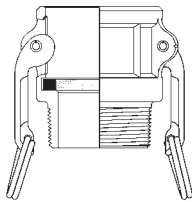

Type B
female coupler x male NPT

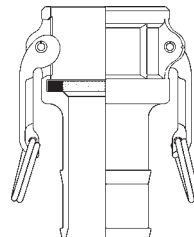

Type C
female coupler x hose shank

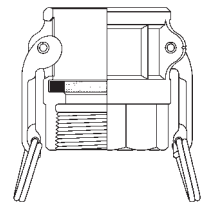

Type D
female coupler x female NPT

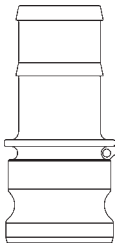

Type E
male adapter x hose shank

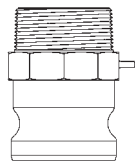

Type F
male adapter x male NPT

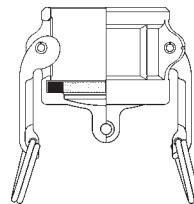

Type DC *
dust cap

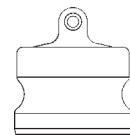

Type DP *
dust plug



* Dust caps and dust plugs are not to be used in pressure applications for safety and environmental reasons.

Under no circumstances should cam and groove couplings be used for compressed air or steam service!

Valves

Brass Ball Valves

Applications:

- controls the flow of various applications, from injection systems to blow-out prevention in wells

Features:

- rated to **600 PSI WOG: 150 PSI** saturated steam
- blow-out proof stems
- meets WW-V 35C, Type II Composition
- full and standard ports available, both repairable
- ball valve handle replacements available, call Dixon® for information

Materials:

- body, balls and stems: brass
- handles and nuts: plated steel with vinyl sleeves
- glass-filled reinforced PTFE seats and stuffing box ring; stem seals and washers

Sizes:

- ¼", ⅜" and ½" in full port design
- ¾", 1", 1¼", 1½", 2", 2½" and 3" in standard port design



Locking Handle Brass Ball Valves

Applications:

- controls the flow of various applications, from injection systems to blow-out prevention in wells

Features:

- rated to **600 PSI WOG: 150 PSI** saturated steam
- blow-out proof stem
- stainless steel sliding lock mechanism secures handle in open or closed position; can be padlocked opened or closed
- full and standard ports available, both repairable

Materials:

- body and stems: brass
- ball: chrome-plated brass
- stem: RPTFE

Sizes:

- ¼", ⅜" and ½" in full port design
- ¾", 1", 1¼", 1½" and 2" in standard port design

sliding lock mechanism

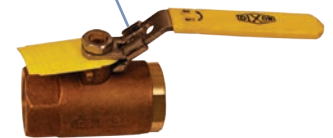

3-Way Diverting Ball Valves

Applications:

- controls or divert the flow of media in various applications, from injection systems to blow-out prevention in wells

Features:

- rated to **400 PSI WOG: 100 PSI** saturated steam
- blow-out proof stem
- PTFE seats, seals, and thrust washer
- adjustable stem packing
- temperature range to 344°F (173°C)
- standard port design

Materials:

- body: brass
- ball: chrome-plated brass

Sizes:

- ½", ¾", 1", 1¼", 1½" and 2"



Locking Handle Stainless Steel Ball Valves

sliding lock mechanism



full port

Application:

- controls the flow of caustic and corrosive fluid in various oil field applications

Features:

- full port rated to **1000 PSI** WOG: **100 PSI** saturated steam
- reduced port rated to **800 PSI** WOG: **100 PSI** saturated steam
- blow-out proof stem design
- temperature range -20°F to 450°F (-29°C to 232°C)
- full and standard ports available
- lockable

Materials:

- body, ball and stem: 316 stainless steel
- seat, joint gasket and thrust washer: PTFE

Sizes:

- 1/4", 3/8", 1/2", 3/4", 1", 1 1/4", 1 1/2" and 2" in reduced port and full port design

sliding lock mechanism

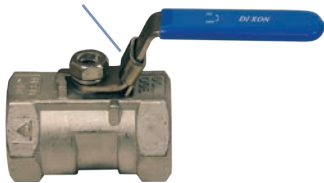

reduced port

Ductile Iron Butterfly Valves



NOT RECOMMENDED FOR STEAM SERVICE

Applications:

- controls flow of crude oil and oil by-products in pipe lines

Features:

- rated to **200 PSI**
- will lock "open" or "closed"
- for use between two 150# flanges
- number of holes on the valve depends on the body size

Materials:

- body: ductile iron, ASTM A536
- disc: nickel plated ductile iron
- top and bottom stems: 416 stainless steel
- seal and stem seals: Buna-N
- bushing: PTFE

Sizes:

- 3", 4", 6" and 8"



Gate Valves

Applications:

- used for steam service in pipe lines or in other high temperature or pressure applications

Features:

- bolted bonnet
- female threaded ends
- ASTM A105, ANSI B120.1: class 800
- rated to **1975 PSI**
- maximum temperature: 800°F (427°C)

Material:

- body: forged steel

Sizes:

- 1/2", 3/4", 1", 1 1/4", 1 1/2" and 2"



Air & Water Utilities



Air King™ Couplings
couplers, ferrules and clamps



Pneumatic Couplers
air supply, testing equipment and blow guns



Filters, Regulators, & Lubricators
combination units, repair kits



Gauges
digital, liquid filled and dry



Fire Hose and Reels
nozzles, racks and safety equipment



PTFE Assemblies
hose, couplings and fittings

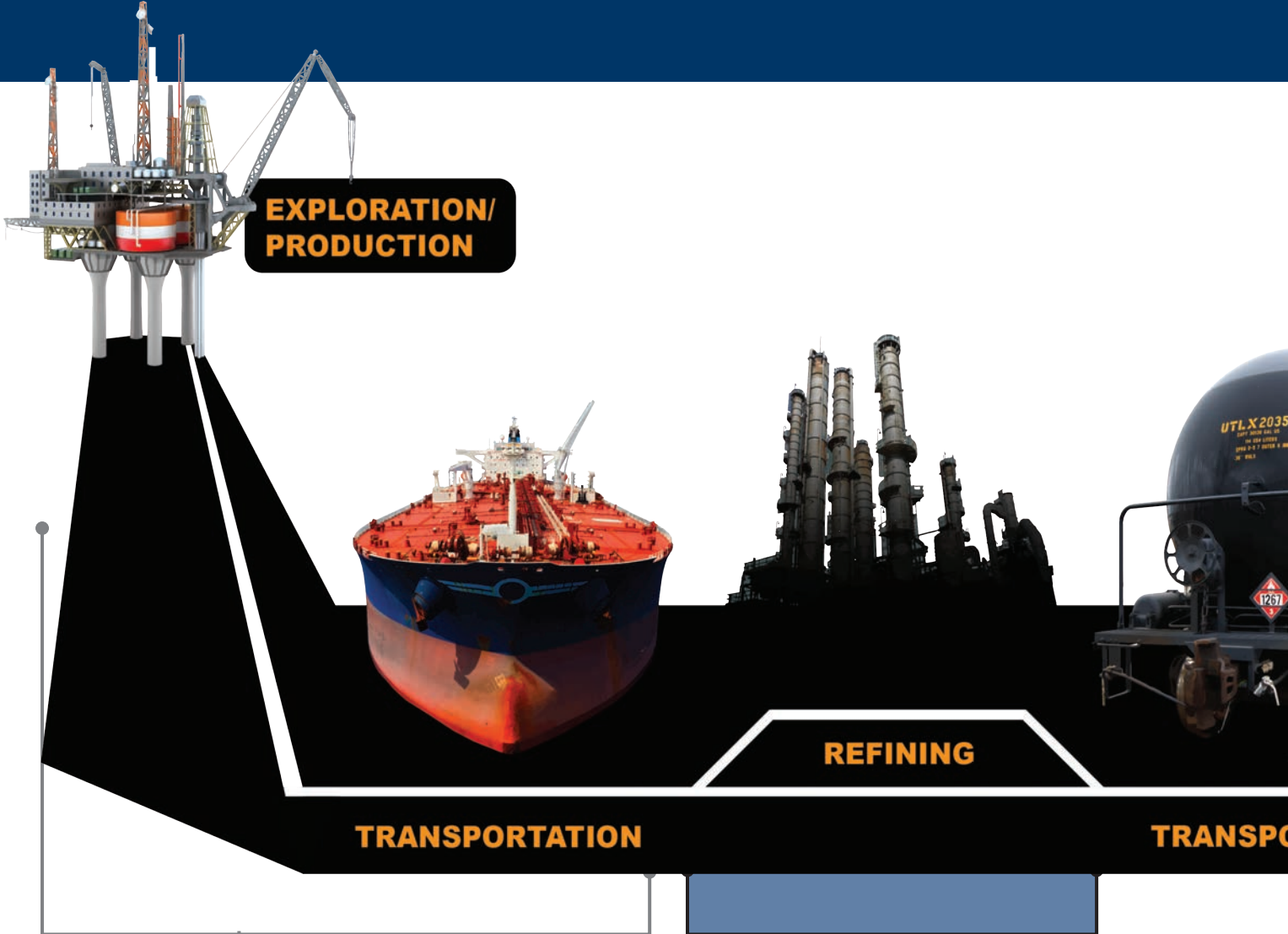

Exploration and Production

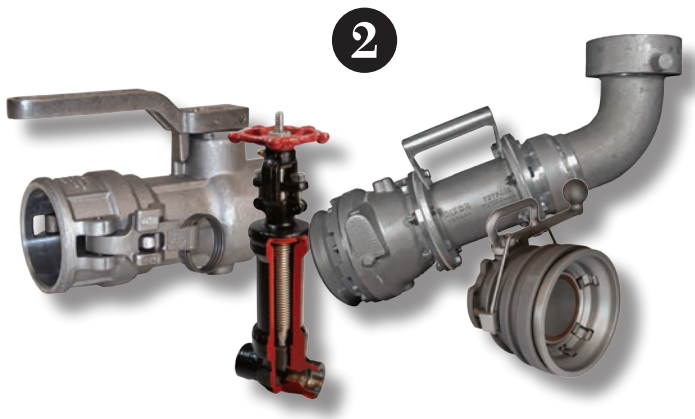

Refining

- Boss™ Low Pressure System Products
- Frac Fittings
- King Crimp™ System
- Hammer Unions
- Control Valves
- Holedall™ Couplings
- Tank Truck and Rail Car/API Fittings & Assemblies

- Dry Break Couplings
- Cam & Groove
- Dry Disconnects
- Ground Joint Systems
- Valves
- API Fittings

PETROCHEMICAL LIFE CYCLE



TRANSPORTATION

TRANSPORTATION

RETAIL



Terminal to Retail

- Overfill Protection
- Loading/Unloading
- Adapters
- Swivels
- Tank Truck and Rack Fittings
- Nozzles

Dixon®, founded in 1916, is a premier manufacturer and supplier of hose couplings, valves, dry-disconnects, swivels, and other fluid transfer and control products. The company's global reach includes a wide range of products for numerous industries including petroleum exploration, refining, transportation, chemical processing, food & beverage, steel, fire protection, construction, mining and manufacturing. Dixon's strategic objective is to create solutions that make products safer, leak-free, longer lasting, and always available.

dixonvalve.com • *Customer Service:* 877.963.4966



The Right Connection®

Dixon®

800 High Street, Chestertown, MD 21620
fx: 800.283.4966



YouTube™



Dixon™
Customer Service